

# **WATER-PRO MODULAR S-90 12/24V DC**

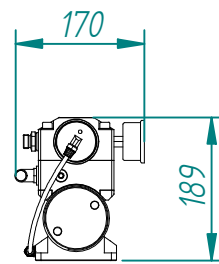

**POMPE ECOSYSTEMS  
ST-08/PRO**

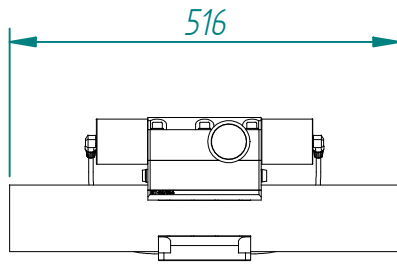
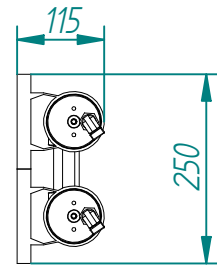
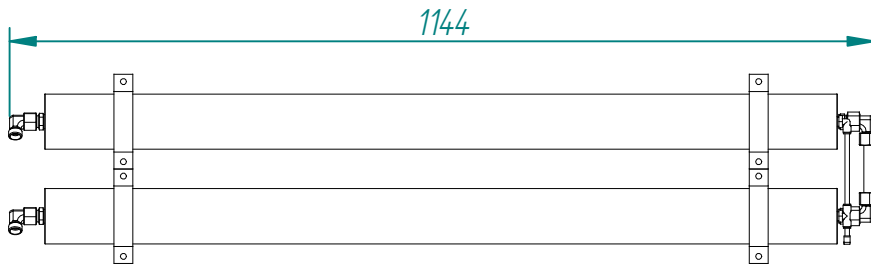

**MEMBRANE 90 LITRES**

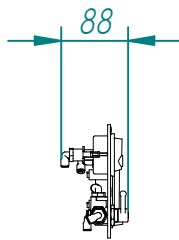
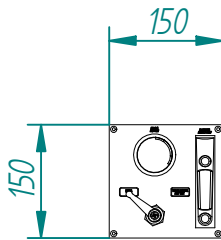

**PANNEAU DE  
CONTRÔLE**

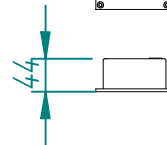
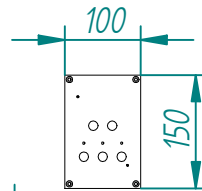

**PANNEAU DE CONTRÔLE  
ELECTRONIQUE**

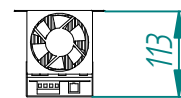
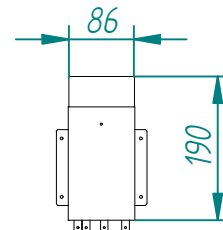

**BOÎTE DE  
PUISSANCE**

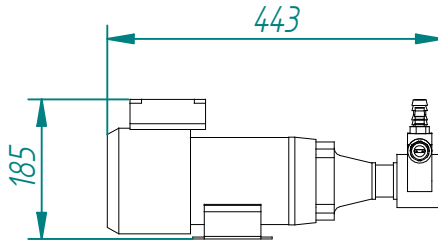
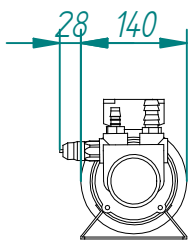

**POMPE BASSE PRESSION  
12/24V DC**

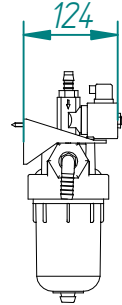
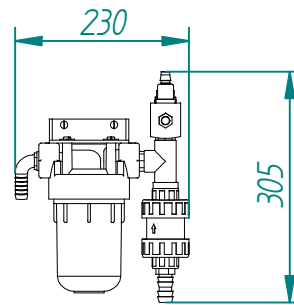

**FILTRE D'ASPIRATION**

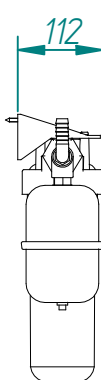
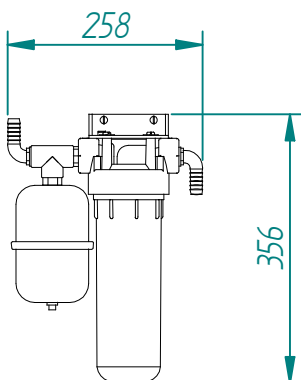

**FILTRE 5 MICRONS**

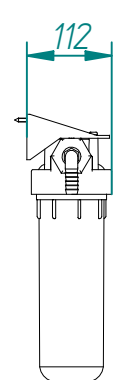
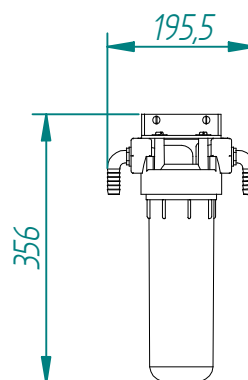

**FILTRE CHARBON**