

# **WATER-PRO MODULAR S-90 220 V AC**

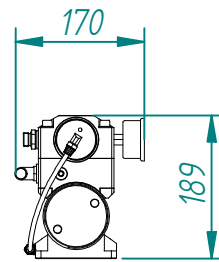

**POMPE ECOSYSTEMS  
ST-08/PRO**

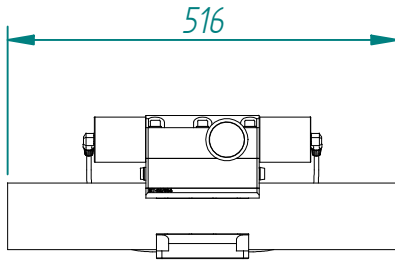
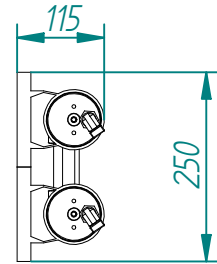
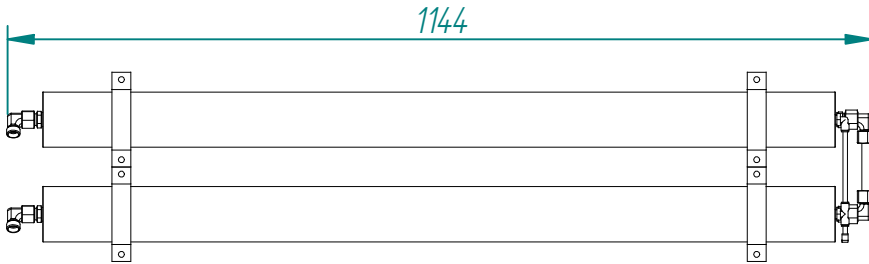

**MEMBRANE 90 LITRES**

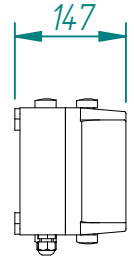
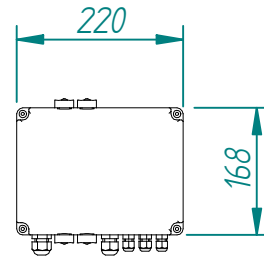
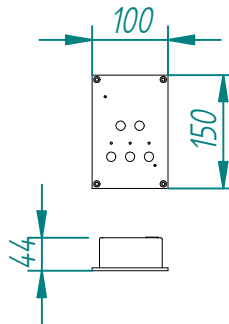
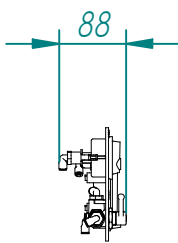
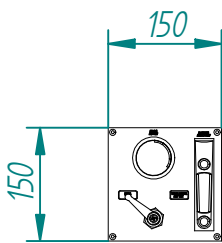

**PANNEAU DE  
CONTRÔLE**

**PANNEAU DE CONTRÔLE  
ELECTRONIQUE**

**BOÎTE VARIETEUR  
FREQUENCE**

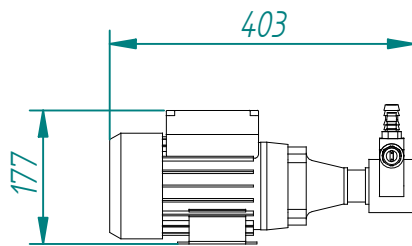
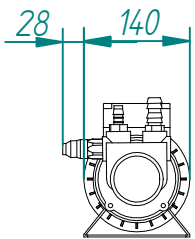

**POMPE BASSE PRESSION  
220 V AC**

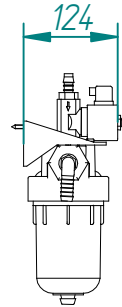
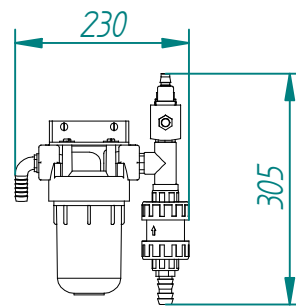

**FILTRE D'ASPIRATION**

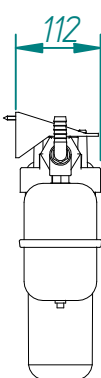
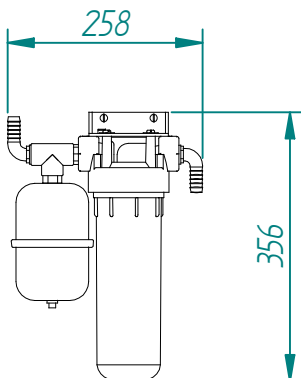

**FILTRE 5 MICRONS**

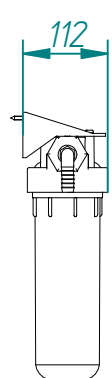
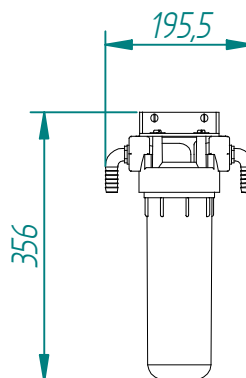

**FILTRE CHARBON**